

# Data Sheet



Article number: 03705006

Description: Fluro rod end BRM 6 L  
threaded left with ball bearing

## Measures

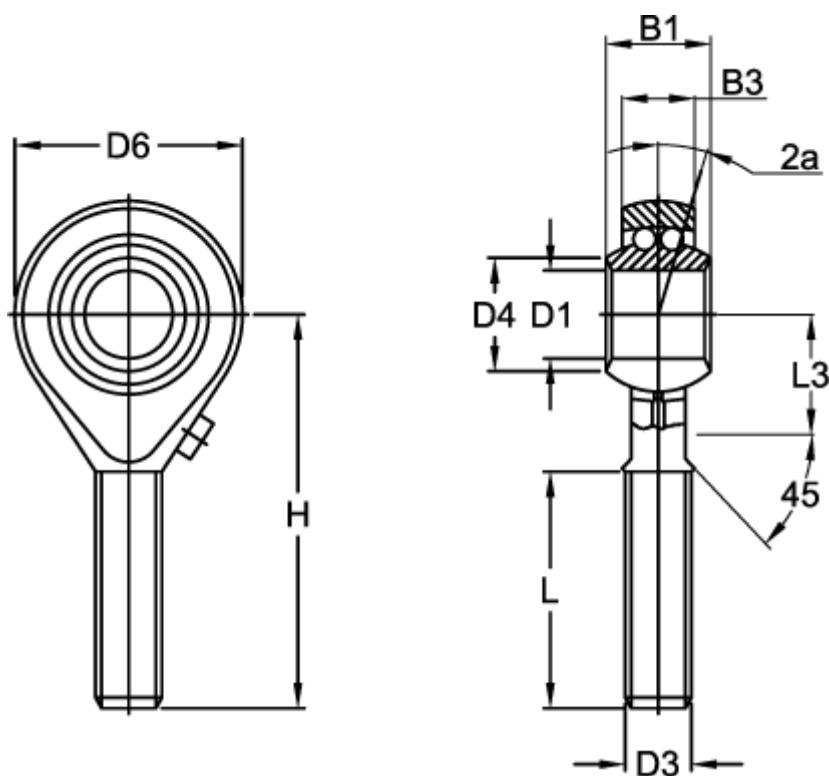

Angel 2a	= 8.0	H	= 36
B1	= 9	L	= 22
B3	= 6.75	L3	= 12
D1	= 6	Max rpm	= 1350
D3	= M6x1	Static load (N)	= 650
D4	= 9.0	Weight (kg)	= 0.019
D6	= 20		
Dynamic load C (N)	= 2750.0		